



**RDF800KN**  
**RDF800KN/NF**

**RDF800KN/VB**

## Touch Screen Flush-mount Room Thermostats with KNX Communications

For 2-pipe, 2-pipe with electrical heater, and 4-pipe fan coil units

For universal applications

For use with compressors in DX type equipment

**RDF800KN**  
**RDF800KN/VB**  
**RDF800KN/NF**

- 
- **KNX bus communications (S-mode and LTE mode)**
  - **Large display with backlight**
  - **2P / PI / P control**
  - **Outputs for ON/OFF or 3-position control**
  - **Outputs for 3-speed or 1-speed fan**
  - **2 multifunctional inputs for keycard contact, external sensor, etc.**
  - **Independent function for window contact and presence detector**
  - **Operating modes: Comfort, Economy and Protection**
  - **Automatic or manual fan speed control**
  - **Automatic or manual heating / cooling changeover**
  - **Minimum and maximum limitation of room temperature setpoint**
  - **Control depending on the room or the return air temperature**
  - **Adjustable commissioning and control parameters**
  - **Commissioning with Synco ACS, ETS5 or via local HMI**
  - **Interoperation into Synco 700**
  - **Integration into Desigo via group (ETS5) or via individual addressing**
  - **Integration into third-party system via group addressing (ETS5)**
  - **AC 230 V operating voltage**
  - **RDF800KN, RDF800KN/VB: Mounting on round box, with min 60 mm diameter or recessed square 86 mm box with 60.3 mm fixing centers and min 40 mm depth**

- **RDF800KN/NF: Mounting on recessed square 86 mm box with 60.3 mm fixing centers and min 40 mm depth, requires additional mounting frame**

## Use

---

Room temperature control (heating or cooling) in individual rooms and zones by means of:

- 2-pipe fan coil units
- 2-pipe fan coil units with electrical heater
- 4-pipe fan coil units
- Chilled /heated ceiling
- Chilled /heated ceiling and electrical heater
- Chilled ceiling and radiator / under floor heating
- Compressors in DX-type equipment
- Compressors in DX-type equipment with electrical heater

The RDF800KN... controls:

- One single or 3-speed fan
- One or two ON/OFF valve actuators
- One ON/OFF valve actuator and one 1-stage electrical heater
- One 3-position valve actuator
- One 1-stage compressor in DX-type equipment, or one 1-stage compressor with electrical heater

Used in systems with:

- Heating or cooling mode
- Automatic heating/cooling changeover
- Manual heating/cooling changeover
- Heating and cooling mode (such as 4-pipe system)

The room thermostats are delivered with a fixed set of applications. The relevant application is selected and activated during commissioning using one of the following tools:

- Synco ACS
- ETS5
- Local DIP switch and HMI

## Functions

---

- Room temperature control via built-in temperature sensor or external room temperature / return air temperature sensor
- Changeover between heating and cooling mode (automatically via local sensor or bus, or manually)
- Selection of applications via DIP switches or commissioning tool
- Selection of operating mode via touch screen
- Temporary Comfort mode extension
- 1- or 3-speed fan control (automatically or manually)
- Display of current room temperature or setpoint in °C and/or °F
- Minimum and maximum limitation of room temperature setpoint
- Keylock function: unlock, total lock and setpoint
- 2 multifunctional inputs, freely selectable for:
  - Window contact
  - Presence detector
  - External room temperature or return air temperature sensor
  - Fault input
  - Monitor input for temperature sensor or switch state
  - Sensor for automatic heating / cooling changeover (RDF...)
  - Dew point sensor (RDF...)

- Electric heater enable (RDF...)
- Advanced fan control function, such as: fan kick, fan start delay, and selectable fan operation (enable, disable or depending on heating or cooling mode)
- Purge function together with 2-port valve in a 2-pipe changeover system
- Reminder to clean fan filters (adjust with P62)
- Floor heating temperature limitation
- Reload factory settings for commissioning and control parameters
- Wizard function for easy commissioning via HMI
- KNX bus (terminals CE+ and CE-) for communication with Synco or KNX compatible devices
- Display of time of day via KNX bus
- Display of outdoor temperature via KNX bus on INFO page
- Time scheduling and central control of setpoints via KNX bus
- With a Synco RMx7xx controller, the energy demand signal of the thermostat is used to optimize energy supply

## Applications

---

The thermostats support the following applications, which can be configured using the DIP switches on the inner side of the thermostat's front panel or a commissioning tool.

Remote configuration

All DIP switches need to be set to **OFF** (factory setting) to select an application via commissioning tool.

**Remote configuration**, via commissioning tool (factory setting)

- Synco ACS
- ETS5

**DIP switches**



## Applications for fan coil systems

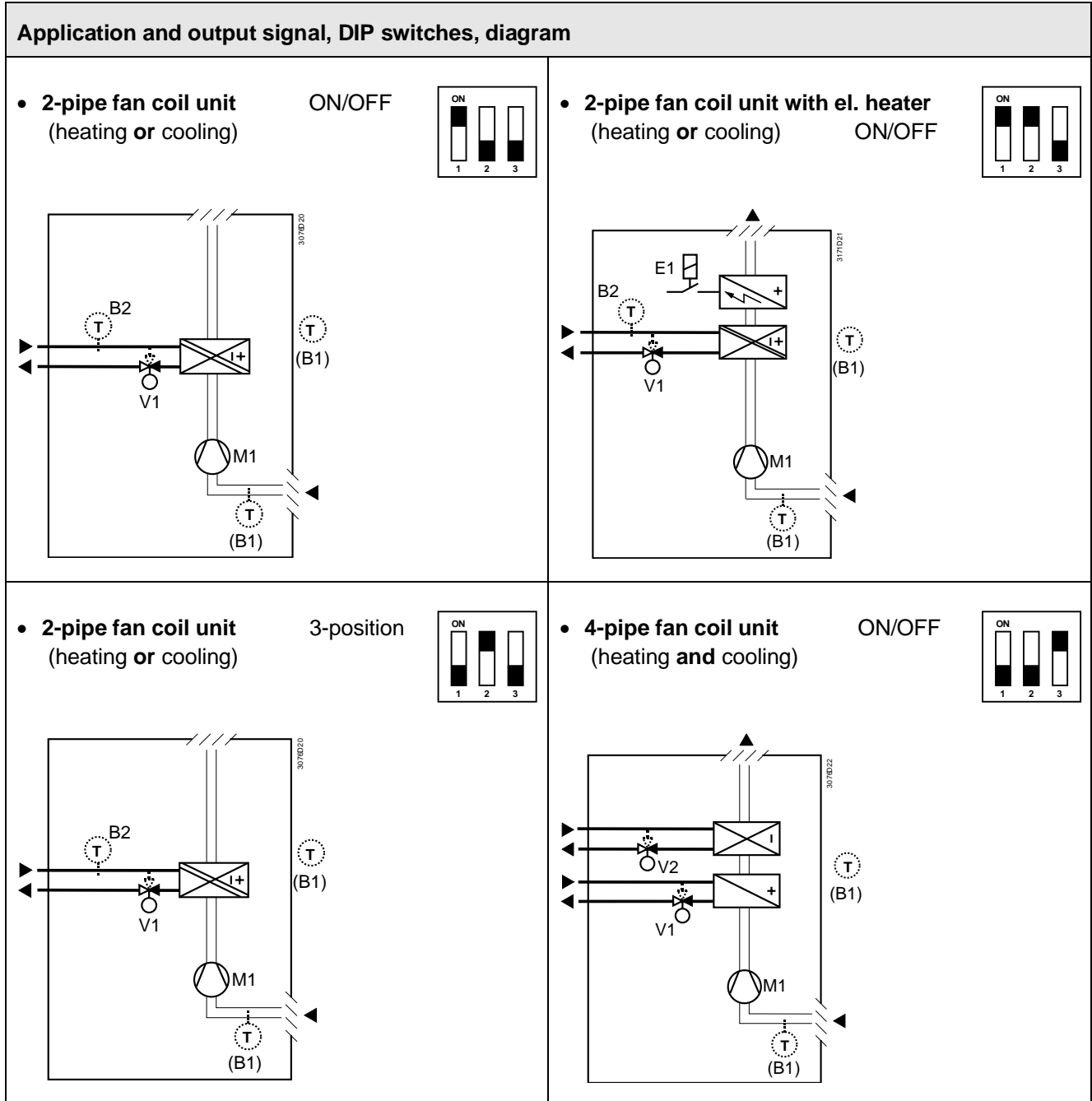

V1 Heating or heating / cooling valve actuator

V2 Cooling valve actuator

E1 Electric heater

B1 Return air temperature sensor or external room temperature sensor (optional)

B2 Changeover sensor (optional)

M1 3- or 1-speed fan

# Applications for Universal systems

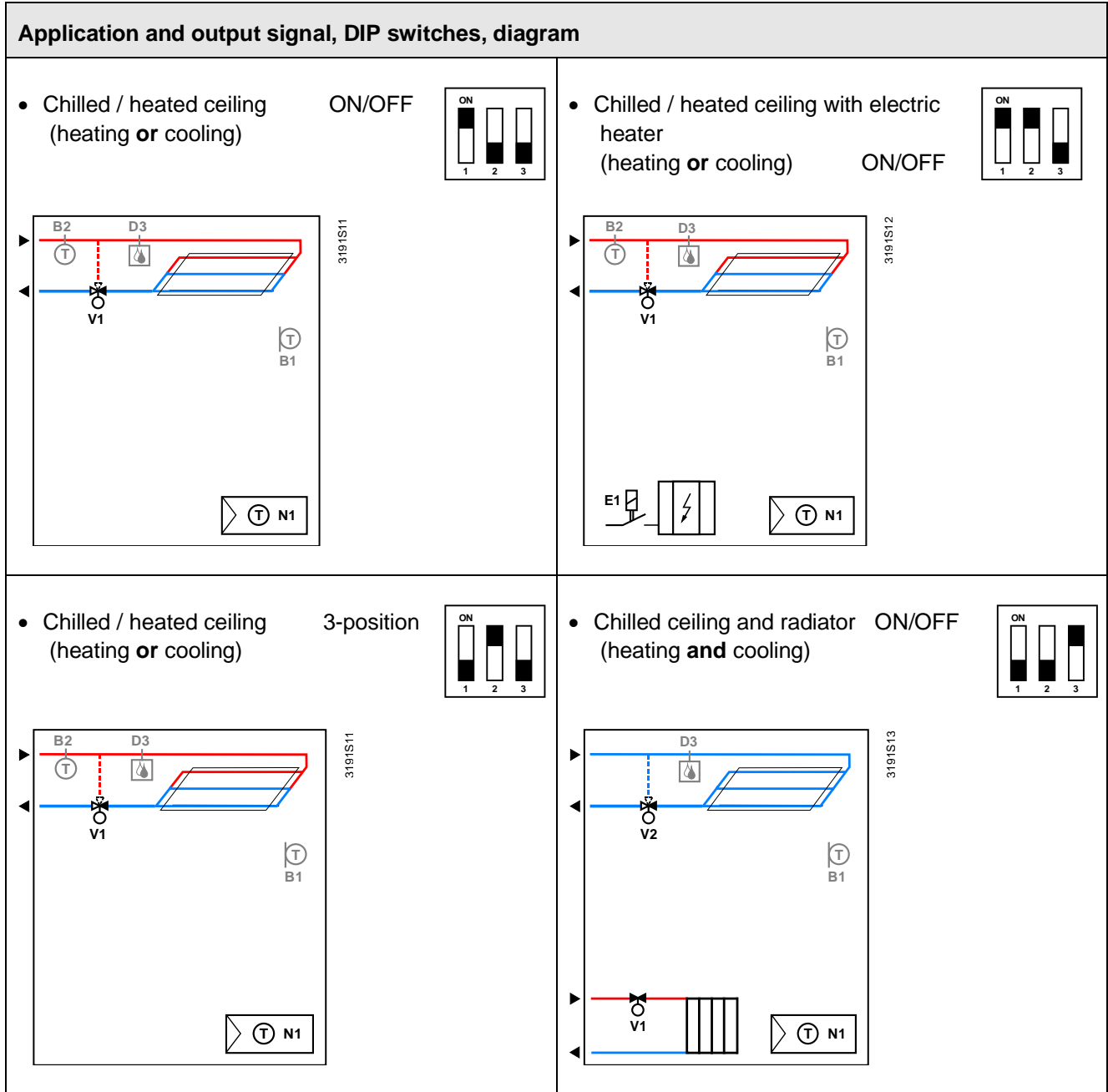

V1 Heating or heating / cooling valve actuator

V2 Cooling valve actuator

E1 Electric heater

B1 Return air temperature sensor or external room temperature sensor (optional)

B2 Changeover sensor (optional)

D3 Dewpoint sensor

## Applications for heat pump systems

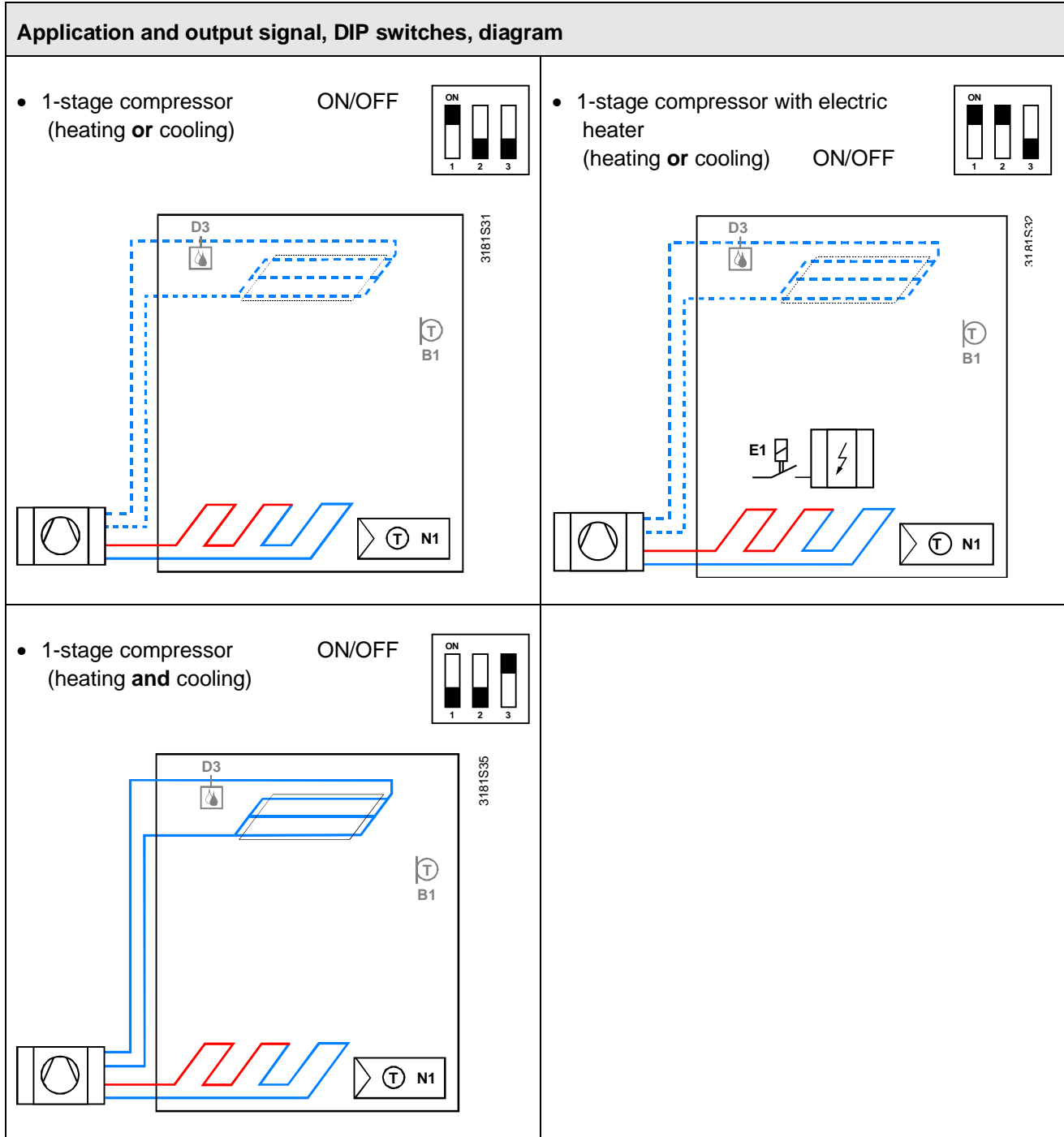

N1 Thermostat  
 Terminal Y1: Heating (H&C) or Heating/Cooling  
 Terminal Y2: Cooling (H&C)  
 E1 Electric heater

B1 Return air temperature sensor or external room temperature sensor (optional)  
 D3 Dewpoint sensor

## Type summary

Product no.	Stock no.	Operating voltage	Control outputs		Suitable conduit box	Color
			3-pos	ON/OFF		
RDF800KN	S55770-T350	AC 230 V	1 <sup>1)</sup>	2 <sup>1)</sup>	Round conduit box	White
RDF800KN/NF <sub>2)</sub>	S55770-T335	AC 230 V	1 <sup>1)</sup>	2 <sup>1)</sup>	Square conduit box <sup>2)</sup>	White
RDF800KN/VB	S55770-T429	AC 230 V	1 <sup>1)</sup>	2 <sup>1)</sup>	Round conduit box	Black









<sup>1)</sup> Selectable: ON/OFF or 3-position

<sup>2)</sup> Mounting frames are not included and must be ordered separately. See "Accessories"

## Ordering







- When ordering, indicate the product number, SSN and name.  
For example: **RDF800KN/NF (S55770-T335) room thermostat**  
**RDF800KN (S55770-T350) room thermostat**
- A mounting frame must be ordered for RDF800KN/NF installation (See "Accessories").
- Order valve actuators separately.

## Equipment combinations

Type of unit		Product no.	Data sheet
Cable temperature sensor or changeover sensor, cable length 2.5 m NTC (3 kΩ at 25 °C)		<b>QAH11.1</b>	1840
Room temperature sensor NTC (3 kΩ at 25 °C)		<b>QAA32</b>	1747
Cable temperature sensor, cable length 4 m NTC (3 kΩ at 25 °C)		<b>QAP1030/UFH</b>	1854
Condensation monitor		<b>QXA2100/ QXA2101</b>	A6V10741072
Electromotoric ON/OFF actuator		<b>SFA21...</b>	4863
Electromotoric ON/OFF valve and actuator (only available in AP, UAE, SA and IN)		<b>MVI.../MXI...</b>	A6V11251892
Zone valve actuators (only available in AP, UAE, SA and IN)		<b>SUA...</b>	4832
Thermal actuator (for radiator valve)		<b>STA23...</b>	4884
Thermal actuator (for small valves 2.5 mm)		<b>STP23...</b>	4884



ON/OFF actuators

### 3-position actuators

Type of unit		Product no.	Data sheet
Electrical actuator, 3-position (for radiator valve)		<b>SSA31...</b>	4893
Electrical actuator, 3-position (for small valve 2.5 mm)		<b>SSP31...</b>	4864
Electrical actuator, 3-position (for small valve 5.5 mm)		<b>SSB31...</b>	4891
Electrical actuator, 3-position (for 2- and 3-port valves / V...P45)		<b>SSC31...</b>	4895
Electrical actuator, 3-position (for small valve 5.5 mm)		<b>SSD31...</b>	4861
Electromotoric actuator, 3-position (for small valves 5.5 mm)		<b>SQS35...</b>	4573

- Note: For the maximal number of actuators in parallel, refer to information in the data sheets of the selected actuators and to this list, depending on which value is lower:
- Parallel operation of max 6 SS... actuators (3-pos) is possible.
  - Parallel operation of max 10 ON/OFF actuators is possible.
  - Parallel operation of SQS35 is not possible.

### Accessories

Designation		Product no. / SSN	Data sheet
Changeover mounting kit (50 pcs / package)		<b>ARG86.3</b>	N3009
Plastic mounting spacer for flush mounted thermostats RDF800KN, RDF800KN/VB for increasing the headroom in the conduit box by 10mm		<b>ARG70.3</b>	N3009
Conduit box for RDF800KN, RDF800KN/VB		<b>ARG71 / S55770-T137</b>	N3009
Single mounting frame <sup>*)</sup> , Ivory White (for RDF800KN/NF only)		<b>ARG800.1 / S55770-T370</b>	--
KNX Power supply 160 mA		<b>5WG1 125-1AB02</b>	--
KNX Power supply 320 mA		<b>5WG1 125-1AB12</b>	--
KNX Power supply 640 mA		<b>5WG1 125-1AB22</b>	--

<sup>\*)</sup> See the dimensions of mounting frame on page 19.



## Mechanical design

The thermostats consist of the following parts:

- Front panel with electronics, operating elements and built-in room temperature sensor.
- Mounting base with power electronics.
- Mounting frame is an additional part to complete the installation for RDF800KN/NF.

The rear of the mounting base contains the screw terminals.  
Slide the front panel in the mounting base and snap on.

## Operation and settings



## Display

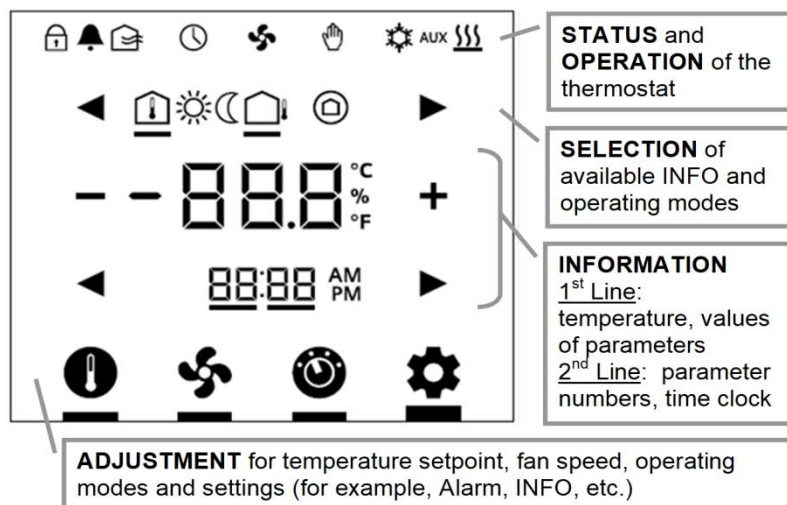

Status symbols:			
	Key lock		Manual override
	Alarm / Service reminder		Cooling active
	Scheduler via bus		Heating active
	FAN ACTIVE	AUX	Auxiliary heat active
Selection symbols:			
	Indoor temperature		Comfort mode
	Outdoor temperature		Economy mode
			Protection mode

Operational icons:	
	Increment, decrement OR selection
	Selection OR move to next items
	Temperature OR parameter values, and etc.
	Time clock (12 / 24 hour), parameter number OR password, and etc.
	Setpoint mode (temperature only)
	Fan mode OR fan speed mode
	Operating mode
	Setting mode

See the "Reference documentation", page 15, for information on how to engineer the KNX bus (topology, bus repeaters, etc.) and how to select and dimension connecting cables for supply voltage and field devices.

## Mounting and installation

Mount the room thermostat on a conduit box. Do not mount on a wall in niches or between bookshelves, behind curtains, above or near heat sources, or exposed to direct solar radiation. Mount about 1.5 m above the floor.

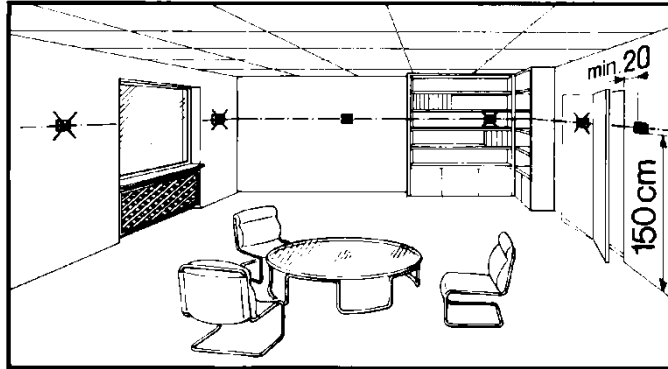

### Mounting / Dismounting



- Do not apply excessive force on screws! The deformation of the mounting frame may lead to improper connections and operation of the unit.
- Mount the room thermostat on a clean, dry indoor place without direct airflow from a heating / cooling device, and not expose to drips or splashes water.
- For RDF800KN, RDF800KN/VB only, in case of limited space in the conduit box, use the mounting spacer ARG70.3 to increase the headroom by 10mm.
- Before removing the front cover, disconnect the power supply.

### Wiring



See the User Manual for the installation instructions enclosed with the thermostat.





- Comply with local regulations to wire, protection and earth the thermostat.
- The device has no internal fuse for supply lines to fan and actuators. To avoid risk of fire and injury due to short-circuits, the AC 230 V mains supply line must have a circuit breaker with a rated current of no more than 10 A.
- Properly size the cables to the thermostat, fan and valve actuators for AC 230 V mains voltage.
- Use only valve actuators rated for AC 230 V.
- The wiring cross section used for power supply (L, N), fan / relays (Qx) and 230 V outputs (Yx - N) must be adapted to the preceding overload protection elements (max 10A) under all circumstances. Comply under all circumstances with local regulations.
- Cables of SELV inputs X1-M / X2-M: Use cables with min 230 V insulation, as the conduit box carries AC 230 V mains voltage.
- Inputs X1-M or X2-M: Several switches (e.g. window contact) may be connected in parallel. Consider overall maximum contact sensing current for switch rating.
- KNX communication cables (input CE+ / CE-): Use cables with min 230 V insulation, as the conduit box carries AC 230 V mains voltage.
- When a KNX bus power supply is connected on the line with communicating thermostats and Synco controllers, the internal KNX power supply of the Synco controllers must be switched off.
- No cables provided with a metal shield.
- Disconnect from supply before opening the cover.

## Commissioning notes

### Before power up

Set DIP switches to select the desired application before power up:

1. For remote setup via commissioning tools, set all DIP switches to **OFF** (see "Remote configuration" for more details);
2. For local setup, set DIP switches to select applications (refer to the following table).

Commissioning method	DIP switches	LCD display	Applications
Remote setup		APP NONE	-
Local setup		APP 2P	2-pipe
		APP 2PEH	2-pipe with electric heater
		APP 4P	4-pipe
		APP 2P3P	2-pipe with 3-position output

After DIP switch setting, complete the installation and power up the thermostat.





Note: As soon as the application is changed, the thermostat reloads the factory setting for all control parameters, except for KNX device and zone addresses!



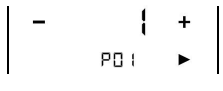

### Wizard

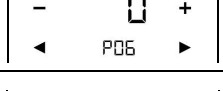
After DIP switches are selected and the thermostat is powered up, the wizard function guides users to configure the basic parameters for normal operation according to the table below.

Touch ◀ / ▶ to advance / return to any parameter;

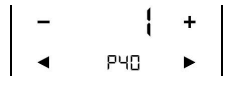
Touch + / - to change value.

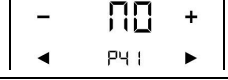
LCD display	Parameter	Range	Factory setting
	Control sequence	0: Heating only 1: Cooling only 2: Manual changeover 3: Auto changeover 4: Heating and Cooling	2-pipe = 1 4-pipe = 4
	User operating mode profile	1: comfort > protection 2: comfort > economy > protection	1
	Selection of °C or °F	0: °C 1: °F	0
	Standard display	0: Room temperature 1: Setpoint	0
	Display info line (2 <sup>nd</sup> line of LCD display)	0: --- (No display) 3: Time of day (12h) via bus 4: Time of day (24h) via bus	0
	Fan Stage in Deadzone (Comfort mode)	0: Fan OFF 1: Fan speed 1 Heat / Cool 2: Fan speed 1 Cool only	0

LCD display	Parameter	Range	Factory setting
	Functionality of X1	0: --- No function 1: Ext / Return Temp (AI) 2: H/C changeover (AI/DI) 3: Window open detect (DI) 4: Dew point sensor (DI) 5: Enable electr. Heater (DI) 6: Fault input (DI) 7: Monitor input (Digital) 8: Monitor input (Temp) 10: Presence detection (DI)	3
	Functionality of X2		1
	Operating action of X1	Normal Open (NO) Normal Close (NC)	Normal Open (NO)
	Operating action of X2		
	-	End of wizard	-

If more details are required about parameters, refer to basic documentation P3174.

### Reset

To re-load factory settings for all parameters, set parameter P71 to **ON**. Restart the thermostat after reset, all LCD segments flash, indicating that the reset is correct. 3 seconds later, the thermostat is ready for commissioning by qualified HVAC staff.

### Applications

The room thermostats are delivered with a fixed set of applications. Select and activate the relevant application during commissioning using one of the following tools:

- Local DIP switch and HMI
- Synco ACS
- ETS5

### Connect tool

Connect the Synco ACS or ETS5 tools to the KNX bus cable at any point for commissioning:

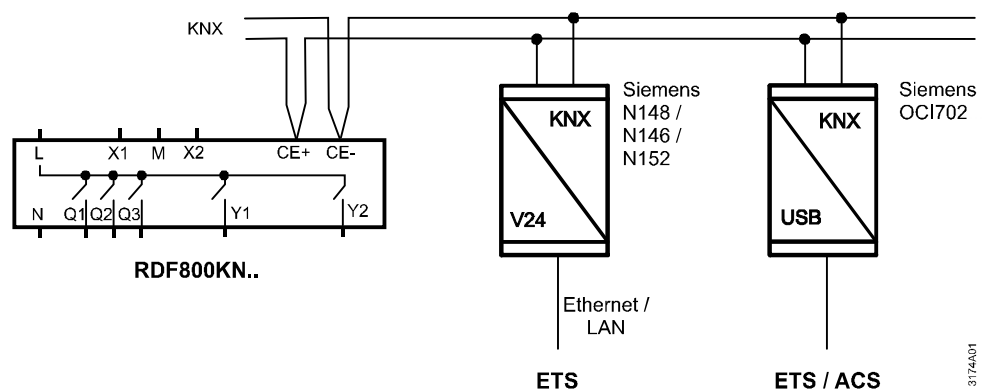

ACS and ETS5 require an interface:

- Ethernet/LAN KNX interface (such as Siemens N148 / N146 / N152)
- OCI702 USB - KNX interface

**Note:** An external KNX bus power supply is required if an RDF800KN... is connected directly to a tool (ACS or ETS5) via KNX interface.

## Control parameters

The thermostat's control parameters can be set to ensure optimum performance of the entire system (refer to basic documentation P3174).

The parameters can be adjusted using

- Local HMI
- Synco ACS
- ETS5

For commissioning via local HMI, refer to user manual B3174... for setting the passwords.

## Control sequence

- The control sequence may need to be set via parameter P01 depending on the application. The factory setting for the 2-pipe application is "Cooling only"; and "Heating and Cooling" for the 4-pipe application.

## Compressor-based application



- When the thermostat is used with a compressor, adjust the minimum output on-time (parameter P48) and off-time (parameter P49) for Y1 / Y2 to avoid damaging the compressor or shortening its life due to frequent switching.

## Calibrate sensor

- Recalibrate the temperature sensor if the room temperature displayed on the thermostat does not match the room temperature measured (after min. 1 hour of operation). To do this, change parameter P05.

## Setpoint and range limitation

- We recommend to review the setpoints and setpoint ranges (parameters P08...P12) and change them as needed to achieve maximum comfort and save energy.

## Programming mode

The programming mode helps identify the thermostat in the KNX network during commissioning.

Touch and hold  for more than 5 seconds to activate programming mode, which is indicated on the display with **Pr09**. Programming mode remains active until thermostat identification is complete.

## Assign KNX device address

Assign device address (P81) via HMI, ACS or ETS5.

With device address set to 255, the communication is deactivated (no exchange of process data).

## Assign KNX group addresses

Use ETS5 to assign the KNX group addresses of the RDF communication objects.

## KNX serial number

Each device has a unique KNX serial number inside the front panel. An additional sticker with the same KNX serial number is enclosed in the packaging box. This sticker is intended for installers for documentation purposes.

## Disposal



The device is considered electrical and electronic equipment for disposal in terms of the applicable European Directive and may not be disposed of as domestic garbage.

- Dispose of the device through channels provided for this purpose.
- Comply with all local and currently applicable laws and regulations.

## Technical data

⚠ Power supply	Rated voltage	AC 230 V	
	Overvoltage category	III	
	Frequency	50/60 Hz	
	Power consumption	Max. 6.0 VA / 2.1 W	
Caution ⚠	No internal fuse! External preliminary protection with max C 10 A circuit breaker required in all cases.		
Outputs	Fan control Q1, Q2, Q3-N	AC 230 V	
	Rating min, max resistive (inductive)	Min. 5 mA, Max. 5(2) A	
⛔ Note!	<b>Fans must NOT be connected in parallel!</b> Connect one fan directly, for additional fans, one relay for each speed.		
	Control output Y1-N / Y2-N (NO)	AC 230 V	
	Rating Min, Max resistive (inductive)	Min. 5 mA, Max. 5(2) A	
	Max. total load current through terminal "L" (Qx+Yx)	Max. 7 A	
Caution ⚠	No internal fuse! External preliminary protection with max C 10 A circuit breakers in the supply line required in all cases.		
Inputs	Multifunctional input X1-M / X2-M		
	Temperature sensor input:		
	Type	See "Equipment combinations"	
	Temperature range	0...49 °C	
	Cable length	Max. 80 m	
	Digital input:		
	Operating action	Selectable (NO / NC)	
	Contact sensing	SELV DC 0...5 V / Max. 5 mA	
	Parallel connection of several thermostats for one switch	Max. 20 thermostats per switch	
	Insulation against mains voltage (SELV)	4 kV, reinforced insulation	
Function of inputs:		Selectable	
External temperature sensor, heating/cooling changeover sensor, window contact, presence detection, dewpoint monitor contact, enable electrical heater contact, fault contact, monitoring input		X1: P38 X2: P40	
KNX bus	Interface type	KNX, TP1-64 (electrically isolated)	
	Bus current	5 mA	
	Bus topology: See KNX manual (see "Reference documentation")		
Operational data	Switching differential, adjustable		
	Heating mode (P30)	2 K (0.5...6K)	
	Cooling mode (P31)	1 K (0.5...6K)	
	Setpoint setting and range		
	☀ Comfort (P08)	21 °C (5...40 °C)	
	☾ Economy (P11-P12)	15 °C / 30°C (OFF, 5...40 °C)	
	⊖ Protection (P65-P66)	8 °C / OFF (OFF, 5...40 °C)	
	Multifunctional input X1/X2		Selectable 0...8, 10
	Input X1 default value (P38)	3 (Window contact)	
	Input X2 default value (P40)	1 (External temperature sensor)	

	Built-in room temperature sensor	
	Measuring range	0...49 °C
	Accuracy at 25 °C	< ± 0.5 K
	Temperature calibration range	± 3.0 K
	Settings and display resolution	
	Setpoints	0.5 °C
	Current temperature value displayed	0.5 °C
Environmental conditions	Storage	As per IEC 60721-3-1
	Climatic conditions	Class 1K3
	Transport	As per IEC 60721-3-2
	Climatic conditions	Class 2K3
Standards and directives	Operation	As per IEC 60721-3-3
	Climatic conditions	Class 3K5 <sup>1)</sup>
	EU Conformity (CE)	8000078258_xx <sup>*)</sup>
	Electronic control type	2.B (micro-disconnection on operation)
	 RCM conformity to EMC emission standard	AS/NZS 61000-6-3
	Safety class	II as per EN 60730
	Pollution class	Normal
	Degree of protection of housing	IP 30 as per EN 60529
	Housing flammability class according to UL94	V-0
Environmental compatibility	The product environmental declaration E3174en contains data on environmentally compatible product design and assessments (RoHS compliance, materials composition, packaging, environmental benefit, disposal).	
General	Connection terminals	Solid wires or prepared stranded wires 1 x 0.4...1.5 mm <sup>2</sup> or 2 x for KNX cables/sensor
	Minimal wiring cross section on L, N, Q1, Q2, Q3, Y1, Y2	Min 1.5 mm <sup>2</sup>
	Housing front color	RAL 9001 white RAL 9004 black
	Weight without / with packaging	0.155 kg / 0.255 kg
	<sup>*)</sup> The documents can be downloaded from <a href="http://siemens.com/bt/download">http://siemens.com/bt/download</a> .	
	<sup>1)</sup> No condensation is allowed.	
<b>Reference documentation</b>		Handbook for Home and Building Control - Basic Principles ( <a href="http://www.knx.org/knx-en/training/books-documentation/knx-association-books/index.php">http://www.knx.org/knx-en/training/books-documentation/knx-association-books/index.php</a> )
	Synco	CE1P3127 Communication via the KNX bus for Synco 700, 900 and RXB/RXL Basic documentation
	Desigo	CM1Y9775 Desigo RXB integration – S-mode
		CM1Y9776 Desigo RXB / RXL integration – individual addressing
		CM1Y9777 Third-party integration
		CM1Y9778 Synco integration
		CM1Y9779 Working with ETS

## Connection terminals

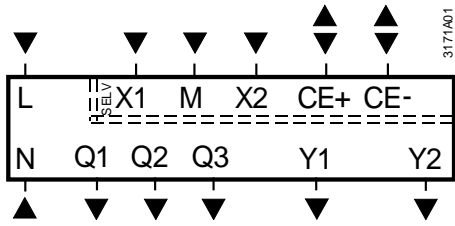

L, N	Operating voltage AC 230 V
Q1	Control output "Fan speed 1 AC 230 V"
Q2	Control output "Fan speed 2 AC 230 V"
Q3	Control output "Fan speed 3 AC 230 V"
Y1, Y2	Control output "Valve" AC 230 V (N.O., for normally closed valves), output for compressor or output for electrical heater
X1, X2	Multifunctional input for temperature sensor (such as QAH11.1) or potential-free switch Factory setting: – X1 = Window contact – X2 = External sensor (function can be selected via parameter P38 / P40)
M	Measuring neutral for sensor and switch
CE+	KNX data +
CE-	KNX data -

## Connection diagrams

### Application

2-pipe / heating or cooling – ON/OFF

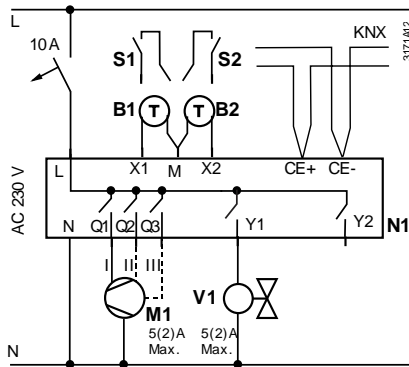

N1	Room thermostat RDF800KN...
M1	1- or 3-speed fan
V1	Valve actuator, 2- or 3-position
V1, V2	Valve actuator, 2-position
E1	Electric heater
C1, C2	1-stage compressor
S1, S2	Switch (keycard, window contact, presence detector, etc.)
B1, B2	Temperature sensor (return air temperature, external room temperature, changeover sensor, etc.)
CE+	KNX data +
CE-	KNX data -

2-pipe, / heating or cooling – 3-position  
– Y1 = Open  
– Y2 = Close

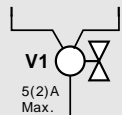

2-pipe and el. heater/  
Heating or cooling and el. heater

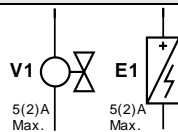

4-pipe / Heating and radiator  
– V1 = Heating  
– V2 = Cooling

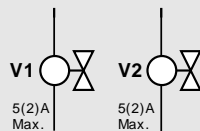

1-stage compressor  
– C1 = Heating and / or  
– C2 = Cooling

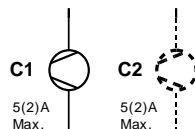

1-stage compressor and electric heater

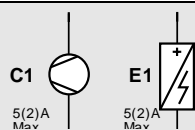



## Dimensions (mm)

RDF800KN/NF  
for square conduit  
boxes only

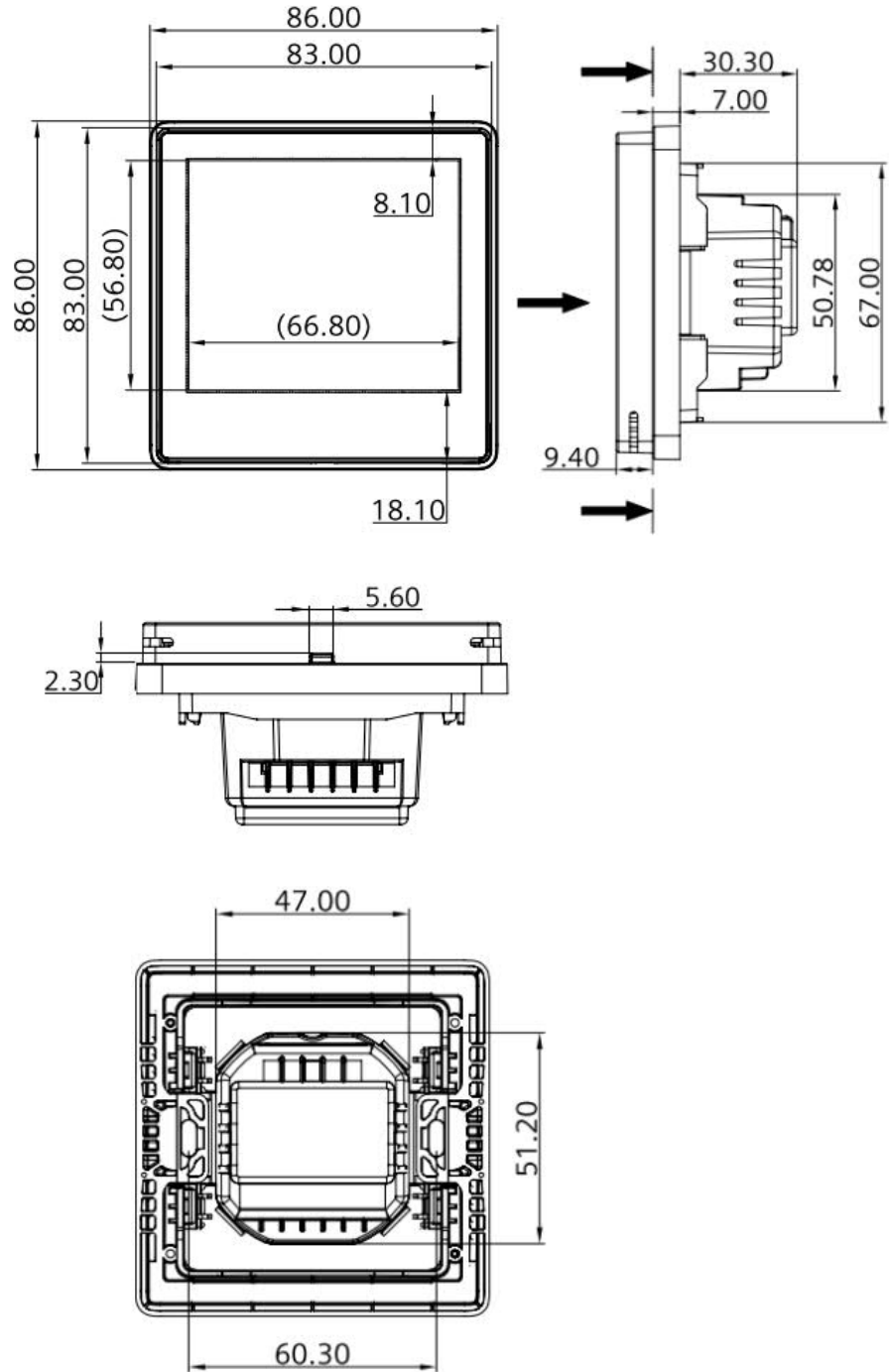

**RDF800KN,  
RDF800KN/VB  
for round  
conduit boxes**

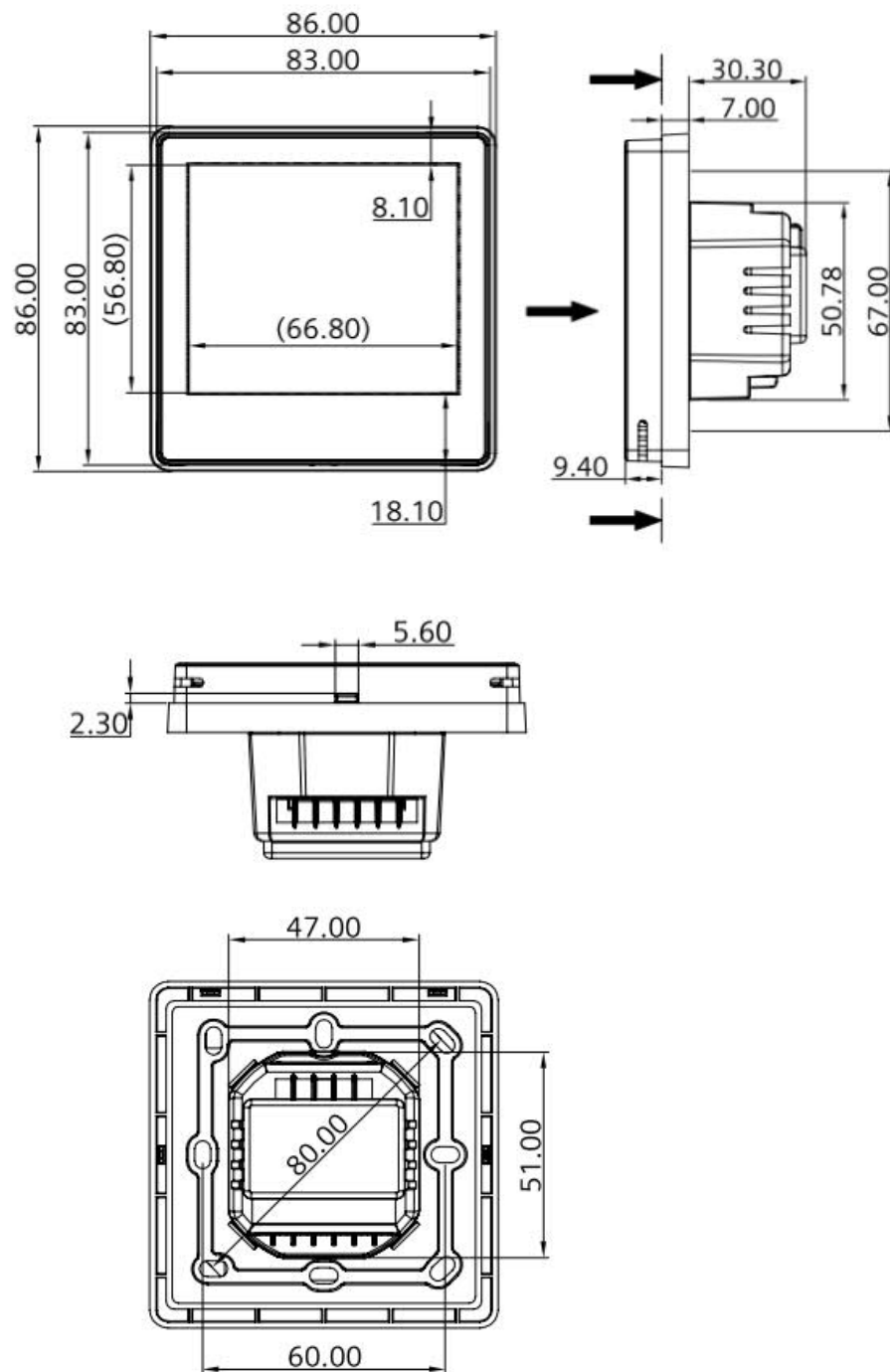

ARG800.1 single  
mounting frame for  
RDF800KN/NF

